

JBL

SURROUND CINEMA
SPEAKERS

SCS160

OWNER'S GUIDE

THANK YOU FOR CHOOSING JBL

For more than 50 years, JBL has been involved in every aspect of music and film recording and reproduction, from live performances to the recordings you play in your home, car or office.

We're confident that the JBL system you have chosen will

provide every note of enjoyment that you expected – and that when you think about purchasing additional audio equipment for your home, car or office, you will once again choose JBL.

Please take a moment to register your product on our

Web site at www.jbl.com. It enables us to keep you posted on our latest advancements, and helps us to better understand our customers and build products that meet their needs and expectations.

JBL Consumer Products

INCLUDED

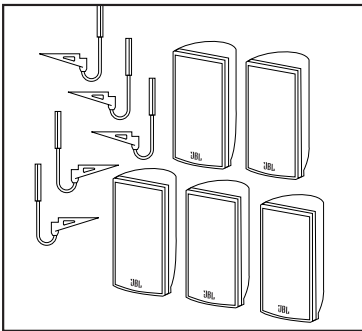

Five satellites for left, right and surrounds. Wall-mount brackets.

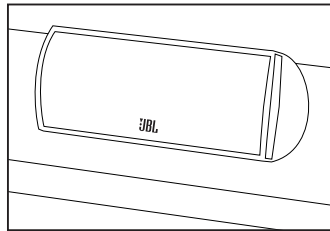

One center channel speaker with adjustable support leg.

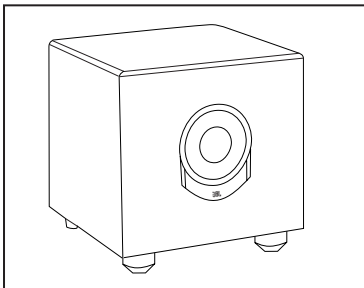

Powered subwoofer.

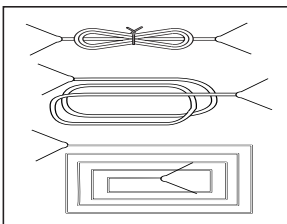

Two 20' speaker cables for connection from receiver to subwoofer.

Two 15' speaker cables for connection from subwoofer to front speakers.

Four 40' speaker cables for connection from receiver to three rear satellites and center speaker.

SPEAKER PLACEMENT

FRONT SPEAKERS

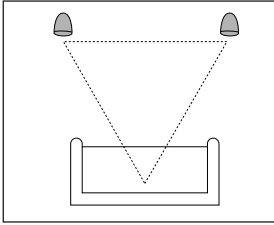

CENTER CHANNEL SPEAKER

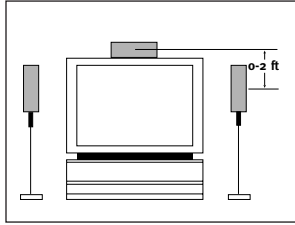

SUBWOOFER

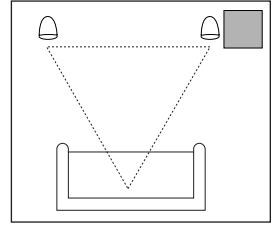

SURROUND SPEAKERS

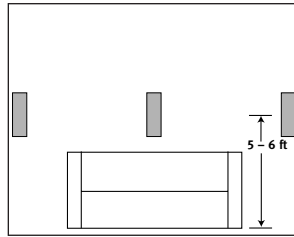
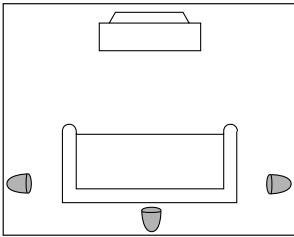

The front speakers should be placed the same distance from each other as they are from the listening position. They should be placed at about the same height from the floor as the listeners' ears will be, or they may be angled toward the listeners.

The center channel speaker should be placed slightly behind the front left and right speakers, and no more than two feet above or below the tweeters of the left and right speakers. It is often convenient to set the center channel speaker on top of the television set, as shown in the drawing. Use the supplied support leg to aim it toward the listener by screwing the leg up, or unscrewing the leg

slightly to angle the speaker down.

Two of the surround speakers should be placed slightly behind the listening position and, ideally, should face each other and be at a level higher than the listeners' ears. If that is not possible, they may be placed on a wall behind the listening position, facing forward. The surround back speaker should be placed on the wall behind the listening position, facing the center channel speaker. You may leave the surround back speaker out of your system altogether if your receiver/processor only supports 5.1 channels. The surround speakers should not call attention to themselves. Experiment with their place-

ment until you hear a diffuse, ambient sound accompanying the main-program material heard in the front speakers.

The low-frequency material reproduced by the subwoofer is mostly omnidirectional, and this speaker may be placed in a convenient location in the room. However, bass reproduction will be maximized when the subwoofer is placed in a corner along the same wall as the front speakers. Experiment with subwoofer placement by temporarily placing the subwoofer in the listening position and moving around the room until the bass reproduction is best. Place the subwoofer in that location.

MOUNTING OPTIONS

SATELLITES AND SURROUNDS

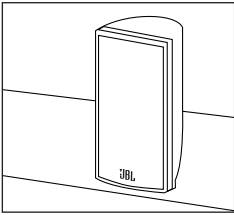

On shelves.

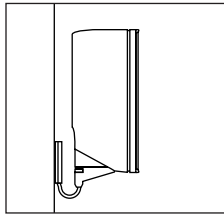

On the wall. Wall brackets are included.

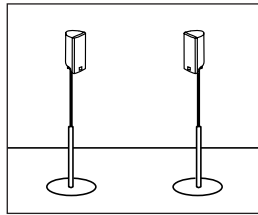

On optional stands (FS400).

WALL-MOUNTING

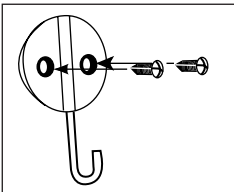

Attach plate to wall. The brackets should be placed, if possible, so that the screws will fasten into a wooden wall stud. If that is not possible, use properly selected wall anchors.

The customer is responsible for proper selection and use of mounting hardware, available through hardware stores, to properly and safely wall-mount the speakers.

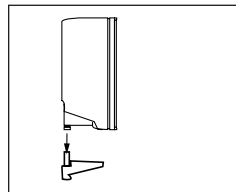

Slide speaker onto support.

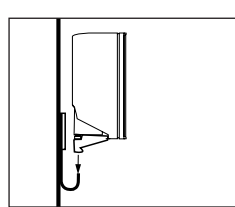

Place speaker and support on wall plate.

SPEAKER CONNECTIONS

CONNECTION TIPS

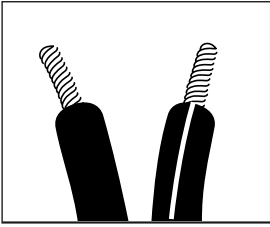

Separate and strip the ends of the speaker wire as shown. Speakers and electronics terminals have corresponding (+) and (-) terminals. Most manufacturers of speakers and electronics, including JBL, use red to denote the (+) terminal and black for the (-) terminal.

The (+) lead of the speaker wire is noted with a stripe. It is important to connect both speakers identically: (+) on the speaker to (+) on the amplifier and (-) on the speaker to (-) on the amplifier. Wiring "out of phase" results in thin sound, weak bass and a poor stereo image.

With the advent of multi-channel surround sound systems, connecting all of the speakers in your system with the correct polarity remains equally important in order to preserve the proper ambience and directionality of the program material.

To connect the supplied speaker wires to the satellite and center speaker terminals, press the red or black plastic tab for the desired terminal, insert the bare end of the wire into the hole and release the tab. Gently tug on the wire to make sure that it is fully inserted.

To use the binding-post speaker terminals on the subwoofer, unscrew the colored collar until the pass-through hole in the center post is visible under the collar. Insert the bare end of the wire through this hole; then screw the collar down until the connection is tight. The hole in the center of each collar is intended for use with banana-type connectors.

DOLBY * PRO LOGIC * (NON-DIGITAL) – SPEAKER LEVEL

Use this installation method for Dolby Pro Logic applications (not Dolby Digital, DTS® or other digital processing), where the receiver/processor does not have a subwoofer output, or a volume-controlled preamp (line-) level output:

Connect your receiver or amplifier's front left and right speaker terminals to the left and right terminals on the subwoofer that are marked "High Level In." Connect the left and right terminals on the subwoofer that are marked "High Level Out" to the corresponding terminals on the back of your front left and right speakers.

Connect your receiver or amplifier's center, surround and surround back speaker terminals to the corresponding terminals on the back of your center and surround speakers.

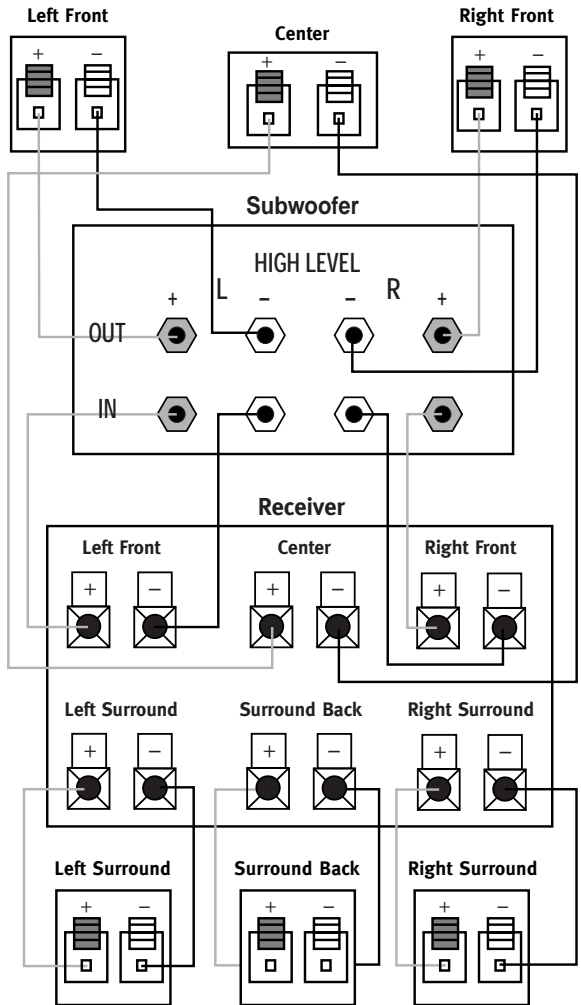

DOLBY PRO LOGIC (NON-DIGITAL) – LINE LEVEL

Use this installation method for Dolby Pro Logic applications (not Dolby Digital, DTS or other digital processing), where the receiver/processor is equipped with a subwoofer output, or a

volume-controlled preamp (line-) level output: Use RCA-type patch cords to connect the line-level subwoofer outputs on your receiver or amplifier to the line-level inputs on the subwoofer. **IMPORTANT:** Do not

use the LFE input on the subwoofer with Dolby Pro Logic processors. **NOTE:** If your receiver or amplifier only has one subwoofer output jack, then you will need to use a Y-connector (not included). Plug the male end of the Y-connector into your receiver or amplifier's subwoofer output jack, and connect each of the two female ends to separate RCA-type patch cords. Finally, plug the RCA-type patch cords into the line-level inputs on the subwoofer.

Connect each speaker to the corresponding speaker terminals on your receiver or amplifier.

Make sure your receiver or processor is correctly configured to indicate that the subwoofer is "On."

Note for advanced users: If your receiver/processor has a built-in low-pass crossover filter for the subwoofer output, you may use the LFE input to bypass the subwoofer's internal crossover.

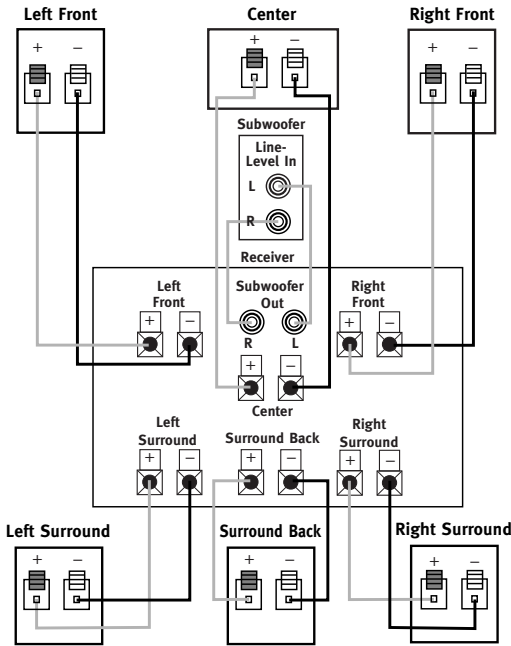

DOLBY DIGITAL OR DTS (OR OTHER DIGITAL SURROUND MODE) CONNECTION

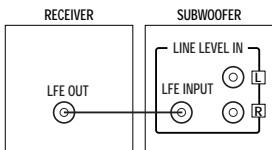

Use this installation method for Dolby Digital, DTS or other digital surround processors:

Use the line-level input jack marked "LFE" for the Low-

Frequency Effects channel. Connect this jack to the LFE output or subwoofer output on your receiver or amplifier. Connect each speaker to the corresponding speaker terminals on your receiver or amplifier.

Make sure that you have configured your surround sound processor for "Subwoofer On." The

receiver should be configured for 6.1-channel operation (if available), and the front left, front right, center and rear speakers should all be set to "Small." If your receiver allows you to set the crossover frequency between the subwoofer and the main speakers, select 120Hz or the setting that is the closest frequency below it.

OPERATION

Move the Master Power switch (marked "Power" ❶) to the "•" (On) position to use the subwoofer. The SCS160 subwoofer will automatically turn on or go into standby (sleep) mode when left in the auto mode ("Auto/

On" switch ❷ in the "Auto" position). When your receiver or amplifier is off, or is not sending program material to the subwoofer, the subwoofer will be in standby mode (LED will be red). When the subwoofer

senses an audio signal, it will automatically turn on (LED will be green). If the subwoofer does not sense a signal after approximately 20 minutes, it will automatically go back into standby mode.

When the "Auto/On" switch ❷ is switched to the "On" position, the subwoofer will remain on, whether or not program material is playing.

If you will be away from home for an extended period of time, or if the subwoofer will not be used, switch the Master Power switch ❶ to the Off position.

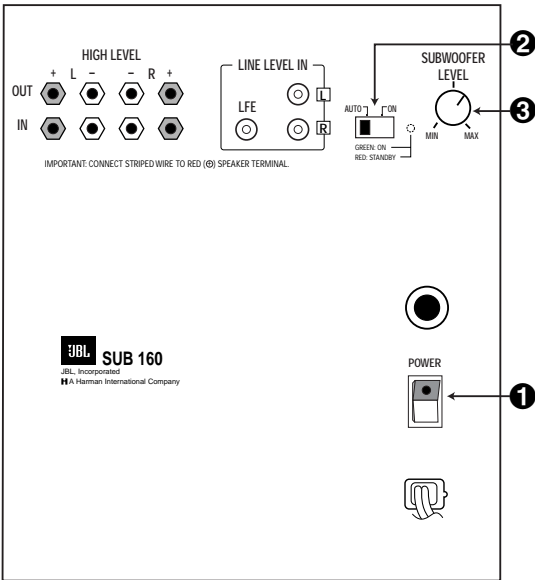

VOLUME

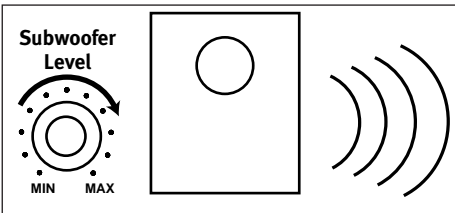

Volume may be adjusted using the Subwoofer Level control ❸ as shown.

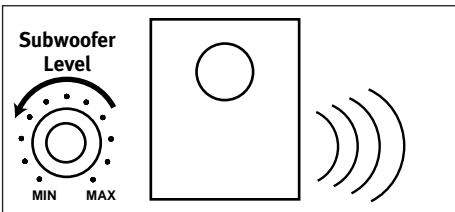

TROUBLESHOOTING

If there is no sound from any of the speakers:

- Check that receiver/amplifier is on and a source is playing.
- Check that the powered subwoofer is plugged in, and its Power switch ❶ is switched on (“.” position).
- Check all wires and connections between receiver/amplifier and speakers. Make sure all wires are connected. Make sure none of the speaker wires are frayed, cut or punctured, or touching each other.
- Review proper operation of your receiver/amplifier.

If there is no sound coming from one speaker:

- Check the “Balance” control on your receiver/amplifier.
- Check all wires and connections between receiver/amplifier and speakers. Make sure all wires are connected. Make sure none of the speaker wires are frayed, cut or punctured, or touching each other.
- In Dolby Digital or DTS modes, make sure that the receiver/processor is configured so that the speaker in question is enabled.
- Turn off all electronics and switch the speaker in question with one of the

other speakers that is working correctly. Turn everything back on, and determine whether the problem has followed the speaker, or has remained in the same channel. If the problem is in the same channel, the source of the problem is most likely with your receiver or amplifier, and you should consult the owner’s manual for that product for further information. If the problem has followed the speaker, consult your dealer for further assistance or, if that is not possible, visit www.jbl.com for further information.

If there is no sound from the center speaker:

- Check all wires and connections between receiver/amplifier and speaker. Make sure all wires are connected. Make sure none of the speaker wires are frayed, cut or punctured, or touching each other.
- If your receiver/processor is set in Dolby Pro Logic mode, make sure the center speaker is not in phantom mode.
- If your receiver/processor is set in Dolby Digital or DTS modes, make sure the receiver/processor is configured so that the center speaker is enabled.

If the system plays at low volumes but shuts off as volume is increased:

- Check all wires and connections between receiver/amplifier and speakers. Make sure all wires are connected. Make sure none of the speaker wires are frayed, cut or punctured, or touching each other.
- If more than one pair of main speakers is being used, check the minimum impedance requirements of your receiver/amplifier.

If there is low (or no) bass output:

- Make sure the connections to the left and right “Speaker Inputs” have the correct polarity (+ and –).
- Make sure the subwoofer is plugged into an active electrical outlet, and is turned on (Power switch ❶ in the “.” position).
- In Dolby Digital or DTS modes, make sure your receiver/processor is configured so that the subwoofer and LFE output are enabled.

If there is no sound from the surround speakers:

- Check all wires and connections between receiver/amplifier and speakers. Make sure all wires are connected. Make sure none of the speaker wires are frayed, cut or punctured, or touching each other.
- Review proper operation of your receiver/amplifier and its surround sound features.
- Make sure the movie or TV show you are watching is recorded in a surround sound mode. If it is not, check to see whether your receiver/amplifier has other surround modes you may use.
- In Dolby Digital or DTS modes, make sure your receiver/processor is configured so that the surround speakers are enabled. When all five satellites are in use, remember to configure your receiver or processor for 6.1-channel operation.
- Review the operation of your DVD player and the jacket of your DVD to make sure that the DVD features the desired Dolby Digital or DTS mode, and that you have properly selected that mode using both the DVD player's menu and the DVD disc's menu.

SPECIFICATIONS

SCS160 System

Frequency Response
30Hz – 20kHz (-6dB)

Satellites

Recommended Power

10 – 100 Watts

Impedance

8 Ohms nominal

Sensitivity

88dB @ 1 Watt/1 meter

Tweeter

One 1/2" (13mm) titanium-laminate dome,
video-shielded

Midrange

Dual 3" (75mm) drivers, video-shielded

Dimensions (H x W x D)

8-1/8" x 3-1/2" x 3-7/8"

206mm x 89mm x 99mm

Weight

2.65 lb/1.2kg

Center

Recommended Power

10 – 100 Watts

Impedance

8 Ohms nominal

Sensitivity

88dB @ 1 Watt/1 meter

Tweeter

One 1/2" (13mm) titanium-laminate dome,
video-shielded

Midrange

Dual 3" (75mm) drivers, video-shielded

Dimensions (H x W x D)

3-1/2" x 8-1/8" x 3-7/8"

89mm x 206mm x 99mm

Weight

2.65 lb/1.2kg

Subwoofer

Amplifier

150 Watts RMS

Woofer

10" (250mm)

Enclosure

Bass reflex

Dimensions (H x W x D)

17-3/4" x 15-3/4" x 16-3/4"

451mm x 400mm x 426mm

Weight

35 lb/15.9kg

All features and specifications are
subject to change without notice.

*Trademarks of Dolby Laboratories.

DTS is a registered trademark of
Digital Theater Systems, Inc.

OWNER'S GUIDE

PRODUCT LINE:
**SURROUND CINEMA
SPEAKERS**

MODEL: **SCS160**

DESIGN GOAL: Bring the thrill of live performance and movie sound to the home environment by calling on JBL's professional engineering leadership.

SATELLITE TYPE: Titanium-laminate-dome tweeter,
sealed enclosure

SUBWOOFER TYPE: Bass-reflex enclosure

PORT DESIGN: FreeFlow™ flared

PROFESSIONAL REFERENCE: Cinema Loudspeaker Series

JBL

PRO SOUND
COMES HOME™

JBL Consumer Products
250 Crossways Park Drive, Woodbury, NY 11797
8500 Balboa Boulevard, Northridge, CA 91329
800.336.4JBL (4525) (USA only)
www.jbl.com

© 2003 Harman International Industries, Incorporated

JBL is a registered trademark of
Harman International Industries, Incorporated.

Part No. 406-000-00890 

H A Harman International Company